

Isolated converter
USB ↔ RS485 / 422

DAT 3580-USB

FEATURES

- Asynchronous serial data transmission
- Automatic baud-rate fitting up to 115.2 Kbps
- Distance up to 1200 m
- Point to point connection or multi-point connection up to 32 modules
- DC or AC power supply
- Galvanic isolation on all ways
- USB cable on front side
- Dedicated USB drivers
- CE / UL / UKCA mark
- DIN rail mounting in compliance with EN-50022



GENERAL DESCRIPTION

The device DAT3580-USB is an isolated interface converter between USB port and asynchronous serial lines RS485 or RS422 that guarantees a full isolation between power supply, USB and serial line RS-485 or 422 removing eventual ground-loop effects and allowing the use of the device even in the heavy environmental conditions. It is designed to operate either on serial interface RS-422 full-duplex 4 wires or RS485 half-duplex 2 wires, with a baud-rate transmission up to 115.2 Kbps.

The transmission is asynchronous without settings of protocol, data format and baud rate.

The device is in compliance with the Directive UL 61010-1 for US market and with the Directive CSA C22.2 No 61010-1 for the Canadian market.

The device is housed in a rough self-extinguishing plastic container which, thanks to its thin profile of 22.5 mm only, allows a high density mounting on EN-50022 standard DIN rail.

USER INSTRUCTIONS

Before to install the device, please read the "Installation Instruction" section. The device converts the serial transmission from USB to RS-485 (2 wires) or RS-422 (4 wires) as follows.

The data incoming from the line TX of USB port are converted and transmitted to the terminals D-E of RS-485 and RS-422. The data incoming from the line RX of RS-485 (terminal D and E) or RS-422 (terminal B and C) are converted and transmitted to the terminal RX of USB port.

The transmission of the signal follows the logic state of every single bit, then it is not necessary to set the protocol, the data format and the baud-rate.

When the data transmission from the USB is off, the RS-485 driver is in the receive condition (high impedance); when the data transmission from the USB goes on the RS-485 driver switch immediately to the transmission condition (low impedance). The low impedance is kept for about 150 us, then the line returns automatically in high impedance (receiver).

TECHNICAL SPECIFICATIONS (Typical @ 25 °C and in the nominal conditions)

USB	RS-485 / RS-422	GENERAL SPECIFICATIONS
In compliance with standard USB 2.0	In compliance with standard RS485 and RS422	DC power supply voltage 18 .. 30 Vdc Reverse polarity protection 60 Vdc max AC power supply voltage 9 .. 18 Vac Max. Current consumption 35 mA
USB Cable USB connector type "A"	Baud-rate up to 115.2 Kbps	ISOLATION Among all the ways 2000 Vac, 50 Hz, 1 min
Cable Length ~ 1.8 m	Cable Length 1200 m / 4000 ft max	ENVIRONMENTAL CONDITIONS Operative temperature -20°C .. +60°C UL Operative Temperature -10°C .. +40°C Storage temperature -40°C .. +85°C Humidity (not condensing) 0 .. 90 % Maximum Altitude 2000 m slm Installation Indoor Category of Installation II Pollution Degree 2
Driver compatibility Windows OS	The reachable maximum distance depends on the number of devices connected, on the type of cable used and its immunity against noises. Number of modules in multipoint up to 32 Switching time TX/RX (RS485) 150 us. Internal terminator resistance (optional) 120 Ohm Connection removable screw terminals	MECHANICAL SPECIFICATIONS Material Self-extinguish plastic IP Code IP20 Wiring wires with diameter 0.8÷2.1 mm ² AWG 14-18 Tightening Torque 0.5 N m Mounting in compliance with DIN rail standard EN-50022 Weight about 160 g.
		CERTIFICATIONS EMC (for the Industrial Environments) Immunity EN 61000-6-2 Emission EN 61000-6-4 UKCA (ref S.I. 2016 N°1091) Immunity BS EN 61000-6-2 Emission BS EN 61000-6-4 UL US Standard UL 61010-1 Canadian Standard CSA C22.2 No 61010-1 CCN NRAQ/NRAQ7 Typology Open Type device Classification Industrial Control Equipment File Number E352854

INSTALLATION INSTRUCTIONS

The device is suitable for fitting to DIN rails in the vertical position.

For optimum operation and long life follow these instructions:

When the devices are installed side by side it may be necessary to separate them by at least 5 mm if panel temperature exceeds 45°C and high power supply value (> 27Vdc).

Make sure that sufficient air flow is provided for the device avoiding to place raceways or other objects which could obstruct the ventilation slits. Moreover it is suggested to avoid that devices are mounted above appliances generating heat; their ideal place should be in the lower part of the panel.

Install the device in a place without vibrations.

Moreover it is suggested to avoid routing conductors near power signal cables (motors, induction ovens, inverters, etc...) and to use shielded cable for connecting signals

CABLING

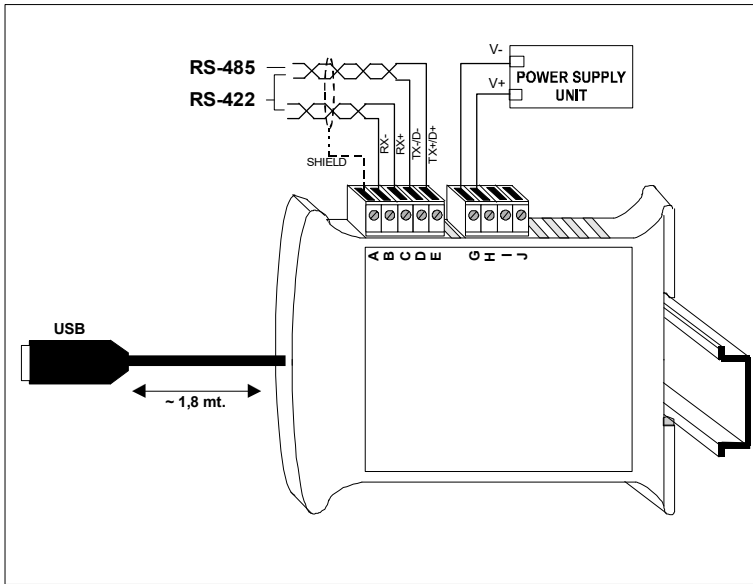

LIGHT SIGNALLING

LED	COLOUR	STATE	DESCRIPTION
PWR	GREEN	ON	Device powered
		OFF	Device not powered
TX	RED	FAST BLINK	Data transmitted from port USB (blink frequency depends to baud-rate)
		OFF	No communication in progress
RX	RED	FAST BLINK	Data received on port RS485/422 (blink frequency depends to baud-rate)
		OFF	No communication in progress

ISOLATION STRUCTURE

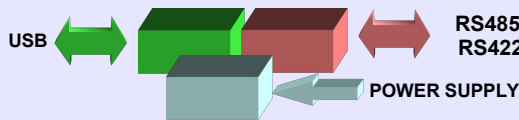

MECHANICAL DIMENSIONS (mm)

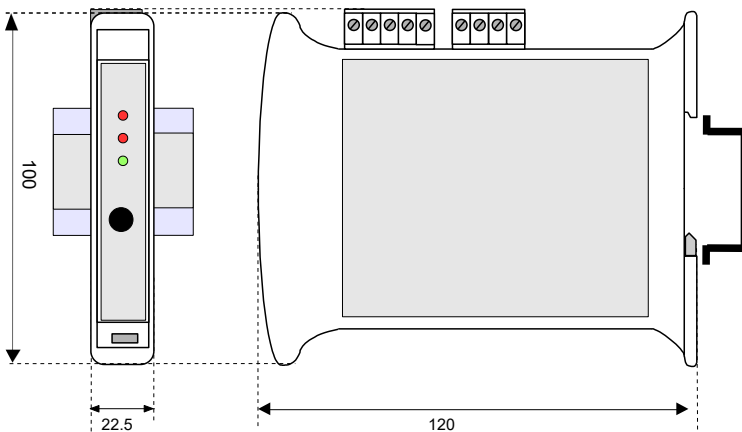

The symbol reported on the product indicates that the product itself must not be considered as a domestic waste. It must be brought to the authorized recycle plant for the recycling of electrical and electronic waste. For more information contact the proper office in the user's city, the service for the waste treatment or the supplier from which the product has been purchased.

WIRING

POWER SUPPLY (*)

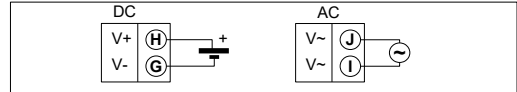

(*) Note: for UL installation the device must be powered using a power supply unit classified NEC class 2 or SELV with limited energy

RS485

Point to point

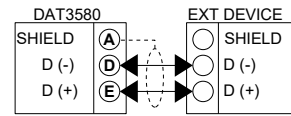

Multi point

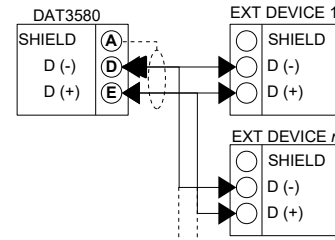

RS422

Point to point

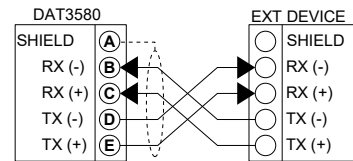

Multi point

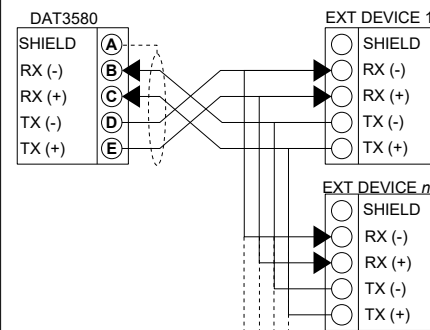

USB DRIVERS

For a correct working, the device needs the installation of dedicated drivers. These drivers are necessary in order to create a Virtual COM port by which execute the communication.

The drivers, compatible with Windows Operating Systems, can be downloaded from the proper section of our web site.

When the procedure of installation is ended, it is necessary verify in the section device manager of Windows the number of the COM port assigned from the operative system to the USB cable of the device.

HOW TO ORDER

In phase of order it is necessary to specify the type of interface (RS485 or RS422).

ORDER CODE:

DAT 3580-USB / 2W

Type of interface:
2W: RS-485 (2 wires)
4W: RS-422 (4 wires)

■ = Requested
□ = Optional